

中山达翔电子有限公司

Zhongshan DaXiang Electronics Co.,Ltd

SPECIFICATION

MODEL: DS.D3663LUA.A8

Approved by DaXiang		
Prepared by 编写	Checked by 审核	Approved by 批准

Please return us one original approved by you with your signatures.

客户承认签章后敬请寄回正本一份

Approved by customer		
Comments 确认意见	Approved by 批准签字	Company's seal 盖章
Customer's Name:		

Content(目录)

1.General Description(概述).....	1
2.Configuration & General Precautions(使用注意事项).....	1
3. Standard Configuration (标准配置).....	2
4.Features(特性说明).....	6
5.PCB Dimension(结构尺寸图).....	9
6.Schematics Of IR Board & Key Board (遥控&按键的原理图).....	10
7.Interface Definition(接口定义).....	11
7.1CONL14(14PIN/2.0): IR & KEY BOARD CONNECTOR(遥控和按键控制接口).....	11
7.2 CONA1(4PIN/2.0): SPEAKER (喇叭接口).....	11
7.3 CONL1(2×15PIN/2.0 OR 2×16PIN/2.0): LVDS INTERFACE CONNECTOR(LVDS 接口).....	12
7.4 CONW03(6PIN/2.0): INVERTER CONNECTOR (背光接口).....	13

1.General Description(概述)

DS.D3663LUA.A8 is a digital DVB-T2/DVB-T/DVB-C TV control board, which is suitable for Europe market.

DS.D3663LUA.A8是一款数字 DVB-T2/DVB-T/DVB-C 电视驱动板卡，适用于欧洲市场。

DS.D3663LUA.A8's USB slot can be used for updating software and playing multimedia, such as MP3 and JPEG.

该款方案的USB 接口可用于软件升级和多媒体播放。

HDMI1.3/1.4compliantwith ARC support,HDCP1.2 compliant.

该款方案的HDMI支持的版本为1.3/1.4兼容ARC 功能，HDCP支持的版本为1.2.

2.Configuration & General Precautions(使用注意事项)

- Protect the board from static electricity to avoid damage to the IC.
请使板卡远离静电以免损坏 IC。
- Keep the board away from conductor when it is working.
确保板卡工作时远离导体。
- Don't press, distort or disassemble the board.
请勿强压、扭曲或拆解板卡。
- Clean the board with soft dry cloth when it's dirty.
如果板卡脏了，请用干布擦拭。
- Don't switch on the power supply before panel is correctly connected.
正确连接好屏线前请勿通电。
- Relative humidity: $\leq 80\%$
相对湿度: $\leq 80\%$ 。
- Storage temperature: $-10\sim 60^{\circ}\text{C}$
储存温度: $-10\sim 60^{\circ}\text{C}$
- Operation temperature: $0\sim 40^{\circ}\text{C}$
工作温度: $0\sim 40^{\circ}\text{C}$
- The brightness of panel is influenced greatly by temperature, you should measure it after power on 10~30 minutes.
因屏的亮度易受温度影响，请在开机 10~30 分钟后再测量。
- Keep the board surface clean. Check the appearance of the board if there has any defective parts, such as dilapidate, weighty nick, etc.
保持产品表面整洁。检查产品外观是否有明显品质不良存在，如：破损，严重划痕等。

3. Standard Configuration (标准配置)

Pictures are for reference only, specific to prevail in kind.

图片仅供参考，请以实物为准。

标准配置1 (Standard Configuration 1)															
特点 Features	通用型 1 (两路 AV IN) Domestic 1 (Difference: 2 AV IN)														
主方案 Main chipset	MSD3663LUA-Z1														
端子功能 Terminal Functions	【 DS.D3663LUA.A8】DC输入(12V), VGA ,HDMI , AV IN 1,AV IN 2 ,PCAUDIOIN,EARPHONE, USB ,TV														
高频头 Tuner	R842(IEC 头)														
驱屏电压 Power to Panel	3.3V、5V、12V (通过跳帽选择, 出厂状态5V)														
客户特殊需求 Special Requirements															
按键类型 Button Types	对地按键接口														
端子图片 Terminal Picture	<p>FRONT VIEW OF DS.D3663LUA.A8 (前视图)</p>  <table border="1" data-bbox="486 1568 1449 1635"> <tr> <td>DC IN</td> <td>USB</td> <td>HDMI</td> <td>VGA</td> <td>AV IN1</td> <td>PC AUDIO IN</td> <td>RF IN</td> <td>EARPHONE</td> </tr> </table> <p>SIDE VIEW OF DS.D3663LUA.A8 (右视图)</p>  <table border="1" data-bbox="805 1881 1125 1971"> <tr> <td>CVBS 2</td> <td>R</td> <td>L</td> </tr> <tr> <td>IN</td> <td colspan="2">Audio in</td> </tr> </table>	DC IN	USB	HDMI	VGA	AV IN1	PC AUDIO IN	RF IN	EARPHONE	CVBS 2	R	L	IN	Audio in	
DC IN	USB	HDMI	VGA	AV IN1	PC AUDIO IN	RF IN	EARPHONE								
CVBS 2	R	L													
IN	Audio in														

标准配置2 (Standard Configuration 2)																									
特点 Features	通用型2 (一路AV IN,一路AV OUT) Domestic 2 (Difference: 1 AV IN, 1 AV OUT)																								
主方案 Main chipset	MSD3663LUA-Z1																								
端子功能 Terminal Functions	【 DS.D3663LUA.A8】DC输入(12V), VGA ,HDMI , AV OUT,AV IN 2 ,PCAUDIOIN,EARPHONE, USB ,TV																								
高频头 Tuner	R842(IEC 头)																								
驱屏电压 Power to Panel	3.3V、5V、12V (通过跳帽选择, 出厂状态5V)																								
客户特殊需求 Special Requirements																									
按键类型 Button Types	对地按键接口																								
端子图片 Terminal Picture	<p>FRONT VIEW OF DS.D3663LUA.A8(前视图)</p>  <table border="1" style="width: 100%; text-align: center; border-collapse: collapse;"> <tr> <td style="width: 10%;">DC IN</td> <td style="width: 10%;">USB IN</td> <td style="width: 10%;">HDMI</td> <td style="width: 15%;">VGA IN</td> <td style="width: 5%;">CVBS OUT</td> <td style="width: 5%;">R</td> <td style="width: 5%;">L</td> <td style="width: 10%;">PC Audio In</td> <td style="width: 10%;">RF IN</td> <td style="width: 10%;">EARPHONE</td> </tr> <tr> <td></td> <td></td> <td></td> <td></td> <td></td> <td colspan="2">Audio out</td> <td></td> <td></td> <td></td> </tr> </table> <p>SIDE VIEW OF DS.D3663LUA.A8(右视图)</p>  <table border="1" style="width: 100%; text-align: center; border-collapse: collapse;"> <tr> <td style="width: 25%;">CVBS IN</td> <td style="width: 25%;">R</td> <td style="width: 25%;">L</td> <td style="width: 25%;">Audio in</td> </tr> </table>	DC IN	USB IN	HDMI	VGA IN	CVBS OUT	R	L	PC Audio In	RF IN	EARPHONE						Audio out					CVBS IN	R	L	Audio in
DC IN	USB IN	HDMI	VGA IN	CVBS OUT	R	L	PC Audio In	RF IN	EARPHONE																
					Audio out																				
CVBS IN	R	L	Audio in																						

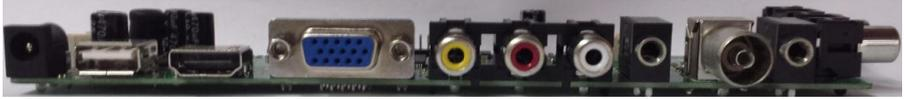
标准配置3 (Standard Configuration 3)																
特点 Features	通用型3 (一路AV OUT,一路YPBPR IN) Domestic 3 (Difference: 1 AV OUT, 1 YPBPR IN)															
主方案 Main chipset	MSD3663LUA-Z1															
端子功能 Terminal Functions	【DS.D3663LUA.A8】 DC输入 (12V) , VGA ,HDMI , AV OUT,YPbPR ,PCAUDIOIN,EARPHONE , USB ,TV															
高频头 Tuner	R842(IEC 头)															
驱屏电压 Power to Panel	3.3V、5V、12V (通过跳帽选择, 出厂状态5V)															
客户特殊需求 Special Requirements																
按键类型 Button Types	对地按键接口															
端子图片 Terminal Picture	<p>FRONT VIEW OF DS.D3663LUA.A8 (前视图)</p>  <table border="1" style="width: 100%; text-align: center; border-collapse: collapse;"> <tr> <td rowspan="2">DC IN</td> <td rowspan="2">USB IN</td> <td rowspan="2">HDMI</td> <td rowspan="2">VGA IN</td> <td rowspan="2">CVBS OUT</td> <td>R</td> <td>L</td> <td rowspan="2">PC Audio In</td> <td rowspan="2">RF IN</td> <td rowspan="2">EARPHONE</td> </tr> <tr> <td colspan="2">Audio out</td> </tr> </table> <p>Right VIEW OF DS.D3663LUA.A8 (右视图)</p>  <table border="1" style="width: 100%; text-align: center; border-collapse: collapse;"> <tr> <td>Y</td> <td>Pb</td> <td>PR</td> </tr> </table>	DC IN	USB IN	HDMI	VGA IN	CVBS OUT	R	L	PC Audio In	RF IN	EARPHONE	Audio out		Y	Pb	PR
DC IN	USB IN						HDMI	VGA IN				CVBS OUT	R	L	PC Audio In	RF IN
		Audio out														
Y	Pb	PR														

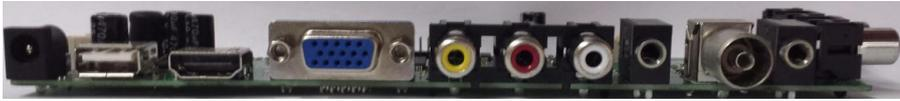
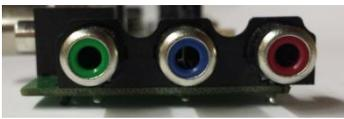
标准配置 4 (Standard Configuration 4)																								
特点 Features	通用型 4 (一路AV IN,一路YPBPR IN) Domestic 4 (Difference: 1 AV IN, 1 YPBPR IN)																							
主方案 Main chipset	MSD3663LUA-Z1																							
端子功能 Terminal Functions	【DS.D3663LUA.A8】DC输入(12V), VGA ,HDMI ,AV IN 1,YPbPR ,PCAUDIOIN,EARPHONE , USB ,TV																							
高频头 Tuner	R842(IEC 头)																							
驱屏电压 Power to Panel	3.3V、5V、12V (通过跳帽选择, 出厂状态5V)																							
客户特殊需求 Special Requirements																								
按键类型 Button Types	对地按键接口																							
端子图片 Terminal Picture	<p>FRONT VIEW OF DS.D3663LUA.A8 (前视图)</p>  <table border="1" style="width: 100%; text-align: center; border-collapse: collapse;"> <tr> <td style="width: 10%;">DC IN</td> <td style="width: 10%;">USB IN</td> <td style="width: 10%;">HDMI</td> <td style="width: 10%;">VGA IN</td> <td style="width: 10%;">CVBS IN</td> <td style="width: 5%;">R</td> <td style="width: 5%;">L</td> <td style="width: 10%;">PC Audio In</td> <td style="width: 10%;">RF IN</td> <td style="width: 10%;">EARPHONE</td> </tr> <tr> <td></td> <td></td> <td></td> <td></td> <td></td> <td colspan="2">Audio in</td> <td></td> <td></td> <td></td> </tr> </table> <p>Right VIEW OF DS.D3663LUA.A8 (右视图)</p>  <table border="1" style="width: 100%; text-align: center; border-collapse: collapse;"> <tr> <td style="width: 33%;">Y</td> <td style="width: 33%;">Pb</td> <td style="width: 33%;">PR</td> </tr> </table>	DC IN	USB IN	HDMI	VGA IN	CVBS IN	R	L	PC Audio In	RF IN	EARPHONE						Audio in					Y	Pb	PR
DC IN	USB IN	HDMI	VGA IN	CVBS IN	R	L	PC Audio In	RF IN	EARPHONE															
					Audio in																			
Y	Pb	PR																						

注意:

- 1、以上标准配置的AV IN2和YPbPr均可以外接小板的形式连接

4.Features(特性说明)

CHIPSET (主芯片)	MSD3663LUA-Z1		
MARKET AREA (销售区域)	Europe (include UK), Australia etc. 欧洲(包括UK), 澳洲等市场		
OSD LANGUAGE (OSD语言)	English, Spanish, French, etc. 英语、西班牙语、法语等.		
PANEL (屏)	Panel Type (屏类型)	TFT LCD With LED Backlight	
	Panel Interface (驱屏接口)	Single/Dual LVDS Interface (单/双LVDS接口)	
	Max Resolution (最大分辨率)	1920x1080	
VIDEO INPUT (视频输入)	ATV	Receiving Range(接收范围)	48.25MHz~863.25MHz
		Input Impedance (输入阻抗)	75Ω
		Video System (视频制式)	PAL,SECAM
		Sound System(声音制式)	BG,DK,I
			NICAM/A2
	DTV	Receiving Range(接收范围)	VHF(174MHz -230MHz)
			UHF(474MHz -862MHz)
		Input Impedance (输入阻抗)	75Ω
		Bandwidth (带宽)	7MHz/8MHz
		Modulation(调制)	DVB-T:COFDM QPSK, 16QAM, 64QAM
			DVB-T2: COFDM QPSK, 16QAM ,64QAM , 256QAM
			DVB-C:16QAM,32QAM,64QAM,128QAM, 256QAM
		Video System (视频制式)	MPEG-2 MP@ML, MPEG-2 MP@HL, H.264
	Sound System(声音制式)	MPEG-1 Layer 1/2, MPEG-2 Layer 2, DD, DD+	
	PC-RGB	Format (格式)	Up to 1920×1080@60Hz
CVBS	Video System(彩色制式)	PAL/NTSC/SECAM	
	Video Level(视频信号幅度)	1.0Vp-p±10%	
HDMI	480i, 480p, , 576i, 576p, 720i, 720p, 1080i, 1080p		
Component	480i, 480p, , 576i, 576p, 720p, 1080i, 1080p		
AUDIO INPUT (音频输入)	PC Audio	Earphone Input Level(输入幅度)	0.2~2.0V _{RMS}

	CVBS Audio	L/R RCA Input	0.2~2.0V _{RMS}
	Component Audio		
VIDEO OUTPUT (视频输出)	CVBS	Video System	PAL/NTSC/SECAM
		Video level	1.0Vp-p±10%
SPEAKER (音频输出)	Frequency Response (频率响应)	100Hz~15KHz @±3dB(1KHz 0dB Reference Signal) (参考信号频率为0dB, 1KHZ)	
	Max Output Power (最大输出功率)	2×2W(4Ω)THD+N<10%@1KHz (Audio Input:0.5VRMS, 音频输入: 0.5VRMS)	
POWER (电源)	DC Input voltage(输入电压)	12VDC±0.6V	
	To Panel (驱屏电压)	12V/5V/3.3V 通过跳帽选择驱屏电压	
	Management (电源管理)	Standby Power Consumption < 0.3W(Board Only) 待机功耗< 0.3W (仅板卡)	
	ADJ	0V ≤ ADJ ≤ 5.0V	
	BL ON	Standby mode : <0.5V On mode: >2.0V(板卡上测量)	
COMB FILTER (梳状滤波功能)	3D		
DEINTERLACE (隔行转逐行)	3D		
KEY FUNCTION (按键功能)	TV/AV,MENU,VOL+,VOL-, CH+,CH-,POWER 信号源, 菜单, 音量+, 音量-, 频道+, 频道-, 电源		
EXPANSIBLE FUNCTIONS	--		

Note: 注意

1. Licenses involved in specifications above are supposed to be obtained by customers themselves.

以上规格涉及 License 部分需要客户自己获取。

2. When 3.3V panel Irush ≥ 1000mA, Inormal ≥ 600mA, please contact with ZVT engineers to confirm 3.3V panel power supply component selection.

3.3V 驱屏电流, 尖峰 ≥ 1000mA, 正常 ≥ 600mA 时, 请与 ZVT 工程师联系确认 3.3V 面板电源组件选择。

3. Max current of USB: 500mA. The board is not suitable for all operating current less than 500mA

mobile hard disk, such as a particularly large impact of current mobile hard disk may cause the board standby
USB 最大电流: 500mA。该板不适合所有工作电流小于 500mA 移动硬盘, 如当前移动硬盘的特别大的冲击可能导致板的待机

4. The normal operating current of 5V panel ≤ 1000mA.

驱屏电压为 5V 的面板正常工作电流 ≤ 1000mA。

5. ADJ generally uses DC voltage adjustment, when the need to use Pulse Width Modulation(PWM) dimming,
please contact and ZVT engineers to confirm ADJ component selection

ADJ 一般采用直流电压调节, 当需要使用脉宽调制 (PWM) 调光时, 请联系 ZVT 工程师确认 ADJ 组件选择。

ELECTRICAL CHARACTERISTICS&REQUIREMENTS(电气特性要求)

Power Supply Mode	Symbol	Voltage Range	Max Current	Ripple Voltage @25℃	Startup Time	Rise Time
12V(Ext. Adaptor)	12V	12V±0.6V	2000mA	120mVP-P	--	≤50ms
12V(Built-In)	12V	12V±0.6V	2000mA	120mVP-P	--	≤50ms
Note: The current of panel, USB, inverter and extension modules are not included in max current.						

USB MULTIMEDIA PLAYBACK FORMAT (USB 多媒体播放支持格式列表)

Media (媒体)	File Ext. (扩展名)	Codec(编码解码器)		Remark(备注)	
		Video(视频)	Audio(音频)		
Movie	.avi	MJPEG	MP3,WMA,AAC, MP2,PCM,AC3	Max Resolution And Frame Rate: 640x480@30fps Max Data Rate: 10 Mbps	
		Xvid,MPEG-2, MPEG-4, H.264		Max Resolution And Frame Rate: 1920x1080@30fps Max Data Rate: 20 Mbps	
	.mp4	MPEG-2,MPEG-4, H.264			
	.ts/ .trp	MPEG-2, H.264			
	.mkv .mov	MPEG-4, H.264			
	.mpg	MPEG-1,MPEG-2			
	.dat	MPEG-1			MP2
	.vob	MPEG-2		Max Resolution: 720x576 Max Data Rate: 20 Mbps	
.rm/ .rmvb	RV8,RV9,RV10	cook	Max Resolution And Frame Rate: 1280x720@30fps Max Data Rate: 10 Mbps		
Music	.mp3	--	MP3	Sample Rate: 32k~48KHz Bit Rate: 32K~320Kbps Channel: Mono/Stereo	
	.wma	--	WMA	Sample Rate: 8k~48KHz Bit Rate: 128K~320Kbps Channel: Mono/Stereo	
	.m4a .aac	--	AAC	Sample Rate: 8k~48KHz Bit Rate: 128K~442Kbps Channel: Mono/Stereo	
Photo	.jpg	Progressive JPEG		Max Resolution: 1024x768	
	.jpeg	Baseline JPEG		Max Resolution: 15360x8640	
	.bmp	--		Max Resolution: 9600x6400	
	.png	Non-Interlaced		Max Resolution: 9600x6400	
		Interlaced		Max Resolution: 1200x800	
.txt	ANSI/UNICODE GB/UTFB		File Size: Max 1MB		
<p>File system: Hi Speed FS, FAT32,FAT16,NTFS(NTFS compressed file is not supported)</p> <p>Note:</p> <ol style="list-style-type: none"> Licenses involved in specifications above are supposed to be obtained by customers themselves MP4 cannot support GMC. 					

5.PCB Dimension(结构尺寸图)

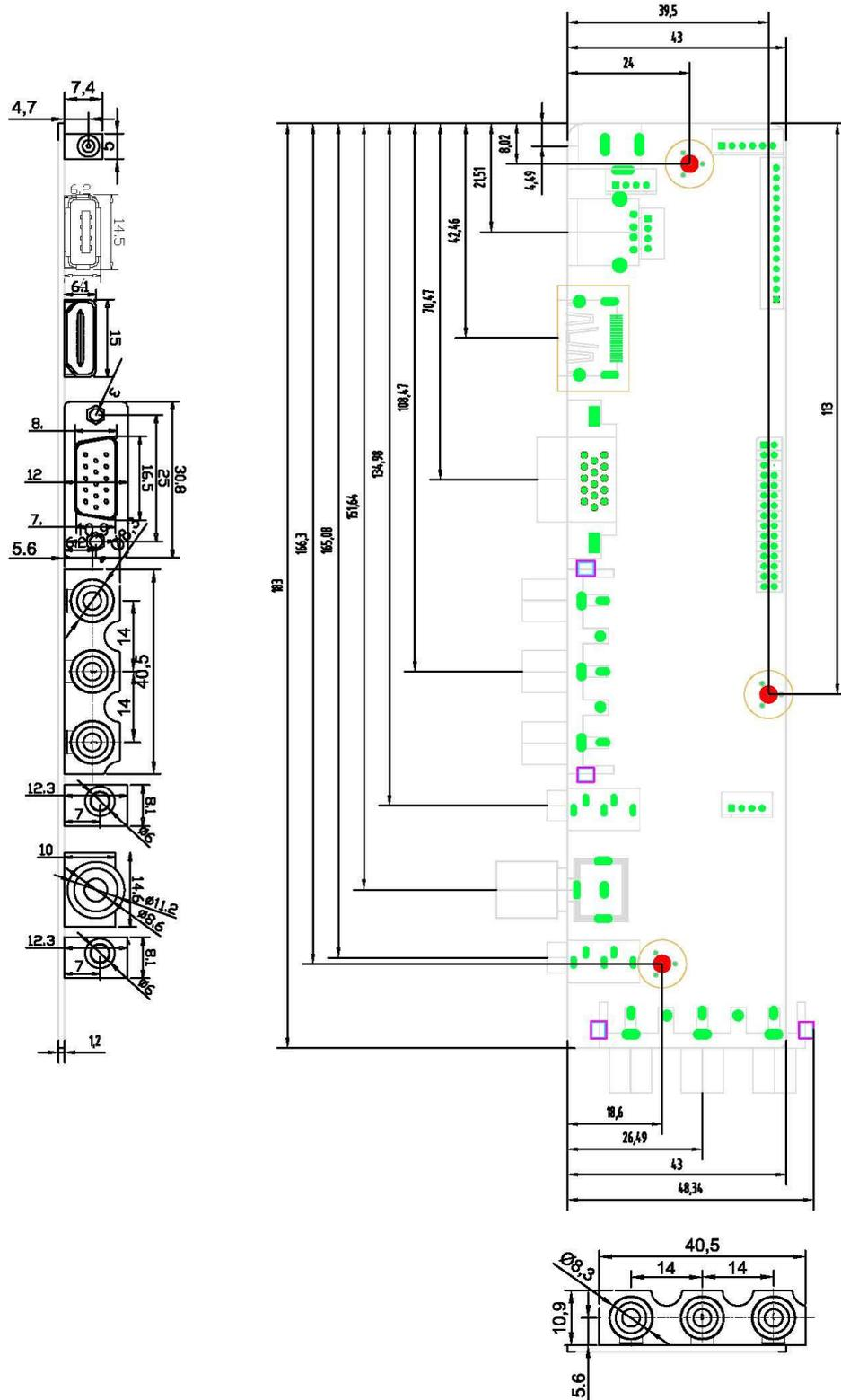

单位: mm

6.Schematics Of IR Board & Key Board (遥控&按键的原理图)

The following schematic is for reference only:

下列原理图仅供参考:

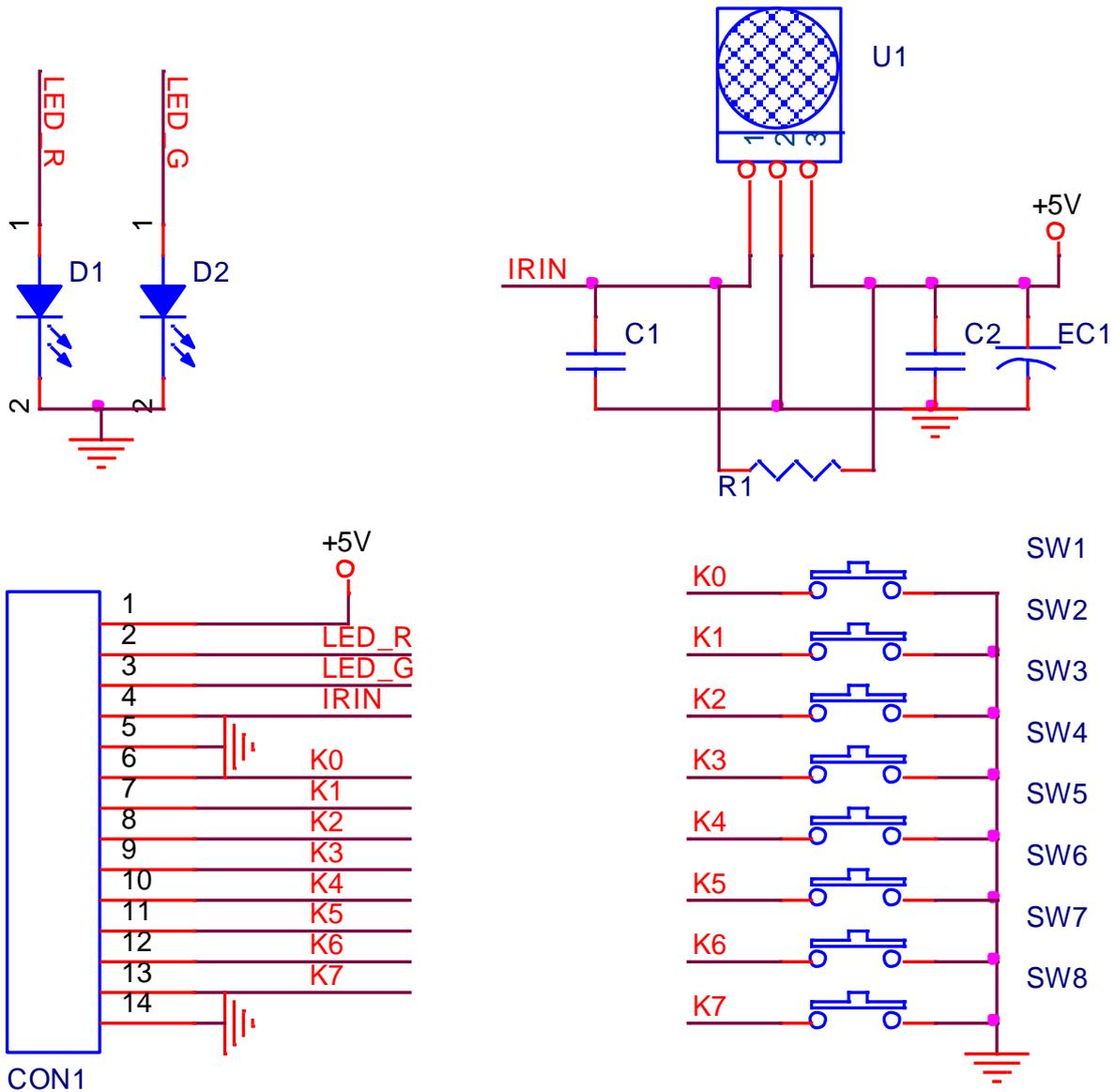

7.Interface Definition(接口定义)

注：方形焊盘定义为 NO.1，通用性板卡的插座定义按照插座开口向内，从左向右开始计数(客户订制型板卡除外)

7.1 CONL14(14PIN/2.0): IR & KEY BOARD CONNECTOR(遥控和按键控制接口)

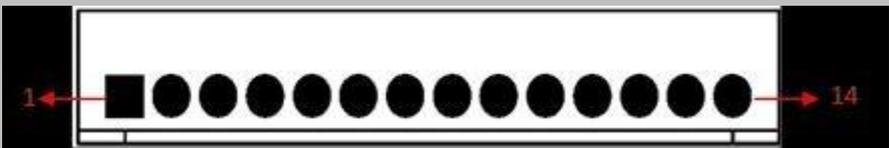

NO.(引脚)	Symbol(定义)	Description(描述)
1	+5V	+5V Power Supply for IR(遥控接收头+5V 供电)
2	R	Red LED(红色 LED)
3	G	Green LED(绿色 LED)
4	IR	IR Input(遥控信号输入)
5	GND	Ground(地)
6	K0	(默认情况下) Power(电源)
7	K1	(默认情况下) Menu(菜单)
8	K2	(默认情况下) Source(信号源)
9	K3	(默认情况下) VOL+(音量+)
10	K4	(默认情况下) VOL-(音量-)
11	K5	(默认情况下) CH+(频道+)
12	K6	(默认情况下) CH-(频道-)
13	K7	(默认情况下) Option (可选)
14	GND	Ground(地)

注：如客户对按键定义有特殊需求时，可以按照客户的实际需求通过软件修改按键定义。可作为POWER键的引脚默认为K0。

7.2 CONA1(4PIN/2.0): SPEAKER (喇叭接口)

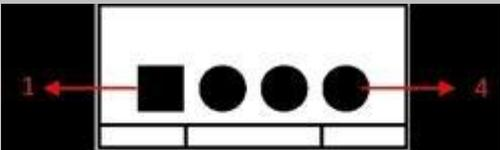

NO.(引脚)	Symbol(定义)	Description(描述)
1	LOUTP	Left Channel Output+(左声道输出+)
2	LOUTN	Left Channel Output-(左声道输出-)
3	ROUTN	Right Channel Output-(右声道输出-)
4	ROUTP	Right Channel Output+(右声道输出+)

7.3 CONL1(2×15PIN/2.0 OR 2×16PIN/2.0): LVDS INTERFACE CONNECTOR(LVDS 接口)

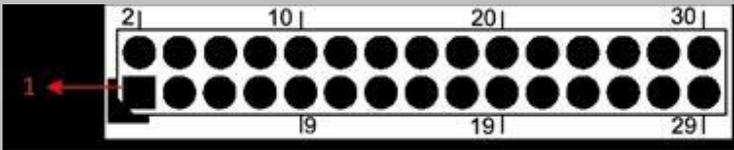

NO.(引脚)	Symbol(定义)	Description(描述)
1	VSEL	Power Supply for Panel
2	VSEL	
3	NC	NC
4	NC	
5	GND	Ground(地)
6	GND	
7	TXO0-	LVDS ODD 0- Signal
8	TXO0+	LVDS ODD 0+ Signal
9	TXO1-	LVDS ODD 1- Signal
10	TXO1+	LVDS ODD 1+ Signal
11	TXO2-	LVDS ODD 2- Signal
12	TXO2+	LVDS ODD 2+ Signal
13	GND	Ground(地)
14	GND	
15	TXOC-	LVDS ODD Clock- Signal
16	TXOC+	LVDS ODD Clock+ Signal
17	TXO3-	LVDS ODD 3- Signal
18	TXO3+	LVDS ODD 3+ Signal
19	TXE0-	LVDS EVEN 0- Signal
20	TXE0+	LVDS EVEN 0+ Signal
21	TXE1-	LVDS EVEN 1- Signal
22	TXE1+	LVDS EVEN 1+ Signal
23	TXE2-	LVDS EVEN 2- Signal
24	TXE2+	LVDS EVEN 2+ Signal
25	GND	Ground(地)
26	GND	
27	TXEC-	LVDS EVEN Clock- Signal
28	TXEC+	LVDS EVEN Clock+ Signal
29	TXE3-	LVDS EVEN 3- Signal
30	TEX3+	LVDS EVEN 3+ Signal
31	SCL	SCL Signal
32	SDA	SDA Signal

7.4 CONW03(6PIN/2.0): INVERTER CONNECTOR (背光接口)

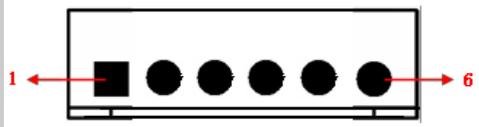
		
NO.	SYMBOL	DESCRIPTION
1	12V	+12V DCPowerSupply
2	12V	+12V DCPowerSupply
3	ON/OFF	Back Light ON/OFF
4	ADJ	Back Light Adjust
5	GND	Ground
6	GND	Ground

7.5 CONW02 (4PIN/2.0): DC INPUT CONNECTOR (直流输入接口)

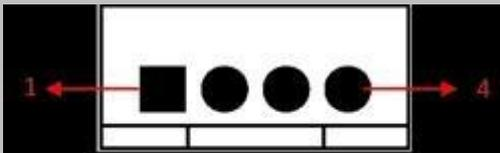
		
NO.(引脚)	Symbol(定义)	Description(描述)
1	GND	Ground
2	GND	Ground
3	12V	+12V DCPowerSupply
4	12V	+12V DCPowerSupply

7.6 CONW3 (4PIN/2.0): OVP CIRCUIT CONNECTOR (过压保护电路接口)

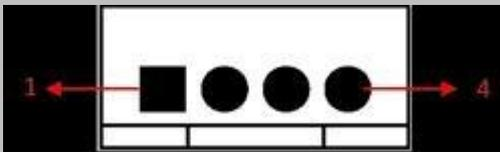
		
NO.(引脚)	Symbol(定义)	Description(描述)
1	12V	+ OVP CIRCUIT IN (MAX 16V Car batteries, Solar battery)
2	GND	Ground
3	12V	+ OVP CIRCUIT OUT
4	12V	+ OVP CIRCUIT OUT

7.7 JR22 (4PIN/2.0): AV IN OR YPBPR IN CONNECTOR (AV IN或者YPBPR IN电路接口)

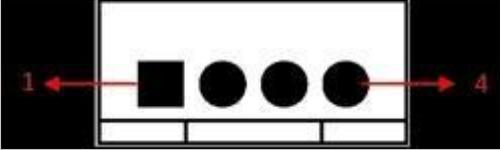
		
NO.(引脚)	Symbol(定义)	Description(描述)
1	1	CVBS IN OR Y IN
2	2	Ground
3	3	R Audio in OR PB IN
4	4	L Audio in OR PR IN